



Light Towers



Light Towers



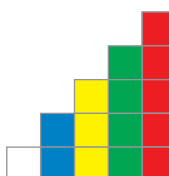

IK Series

Light Towers can be purchased as complete or modularly. Mounting system is easy and plug and turn system without any mounting equipment.

COMPLETE LIGHT TOWER Dia 50 mm (with 100 mm Aluminium connection, body and Lamps)

	LED	LED Flasher	Single Level Buzzer
	IK51 L * X M 03	IK51 F * X M 03	IKM 5Z * M 03
	IK52 L * X M 03	IK52 F * X M 03	
	IK53 L * X M 03	IK53 F * X M 03	
	IK54 L * X M 03	IK54 F * X M 03	
	IK55 L * X M 03	IK55 F * X M 03	

COMPLETE LIGHT TOWER Dia 70 mm (100 mm Plastic connection, body and Lamps)

	LED	LED Flasher	Single Level Buzzer
	IK71 L * X M 01	IK71 F * X M 01	IKM 7Z * M 01
	IK72 L * X M 01	IK72 F * X M 01	
	IK73 L * X M 01	IK73 F * X M 01	
	IK74 L * X M 01	IK74 F * X M 01	
	IK75 L * X M 01	IK75 F * X M 01	

*Shows the voltage of the lamp. When is written "024", it means that it is 24V AC/DC, when it is written "220", it means that it is 220VACType
 *** Shows the connection type. Please check the connection Modules Part for detail. "X" is replaced with "Z" for Buzzer with extra charge.
 For IP65 please add E letter to the end of the code

MODULES

Each Light Tower consists of below components.

1. Body and Cover
2. Signal Modules (5 Colour)
3. Buzzer module
4. LED, Flashing LED
5. Connection



1-Body and Cover

IKM 5 G Dia 50 mm



1-Body and Cover

IKM 7 G Dia 70 mm



* Maximum up to 5 modules can be mounted

2- Signal Modules

Heat resistant polycarbonOte material

IKM 5 50 mm



2- Signal Modules

Heat resistant polycarbonOte material

IKM 7 70 mm



3- Buzzer Modules

IKM 5Z 024
50 mm / 90 dB
IKM 5Z 220
50 mm / 90 dB



























3- Buzzer Modules

IKM 7Z 024
70 mm / 90 dB
IKM 7Z 220
70 mm / 90 dB



LAMPS

4	with LED		with Flashing LED	
24 VDC	IKM L 024		IKM F 024	
	IKM L 024		IKM F 024	
	IKM L 024		IKM F 024	
	IKM L 024		IKM F 024	
	IKM L 024		IKM F 024	
	IKM L 220		IKM F 220	
	IKM L 220		IKM F 220	
	IKM L 220		IKM F 220	
220 VAC	IKM L 220		IKM F 220	
	IKM L 220		IKM F 220	
	IKM L 220		IKM F 220	
	IKM L 220		IKM F 220	

Note. One lamp should be added for each Signal module.

5-Connection

IKA M 01	100 mm Plastic base (Standard for Dia.70 mm, not applicable for Dia 50)
IKA M 02	20 mm Aluminium base
IKA M 03	100 mm Aluminium base (Standart for Dia 50 mm)
IKA M 04	500 mm Aluminium base
IKA D 01	Wall Connection, 100 mm Aluminium
IKA D 02	Adjustable wall elbow
IKA B 10	10 cm Aluminium pipe

Light Towers



NEW IF Series (Multi-Function Light Tower) with Ø 22 mm connection



IF Series

- Single body, multi colour
- Ø22 mm Connection
- Flashing and normal LED mode available in same module.
- 90 dB Buzzer

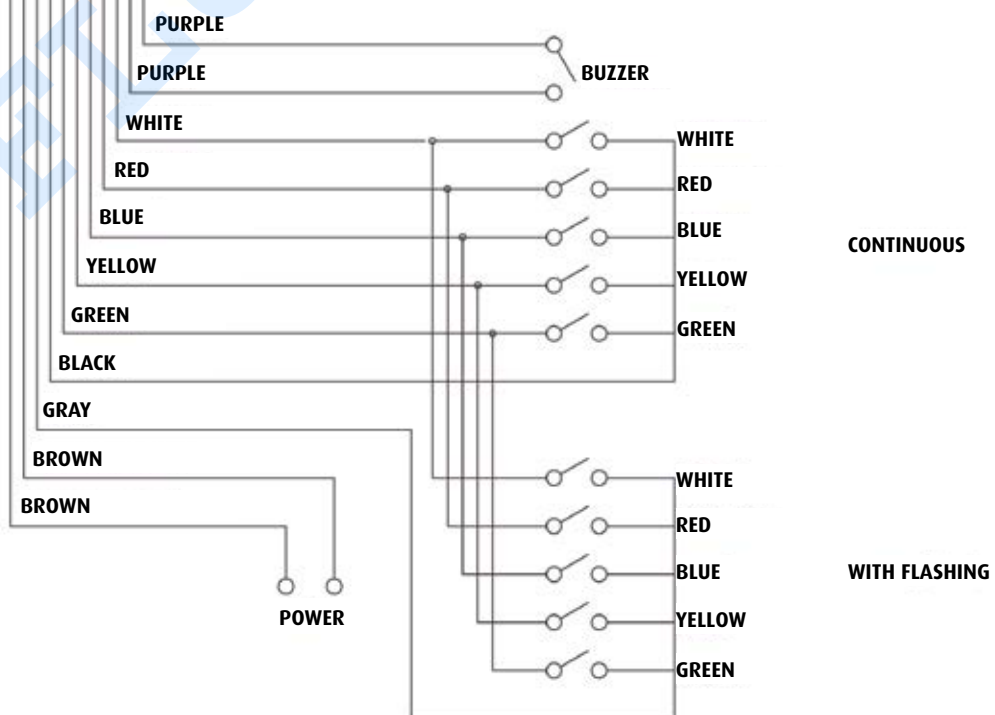

Light Towers



IF5P (Suitable for PLC)

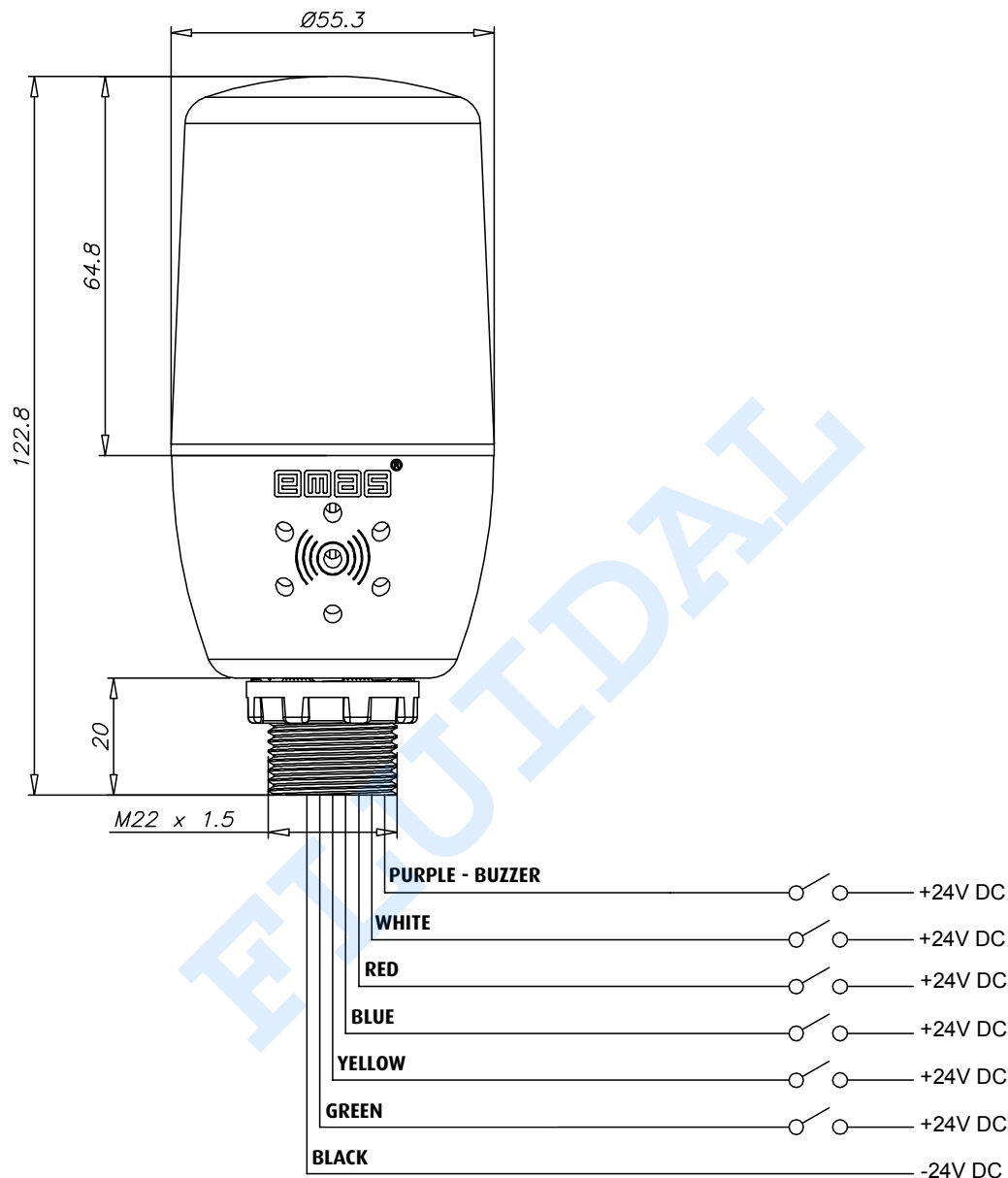

IKAM06



IFAB01

Code	Illumination	Features	Nominal Voltage	Box/Pcs
IF5M024ZM05	LED	with Buzzer	24V AC/DC	1
IF5M220ZM05	LED	with Buzzer	220V AC	1
IF5M024XM05	LED	-	24V AC/DC	1
IF5M220XM05	LED	-	220V AC	1
IF5*024X05	LED	Single Colour	24V AC/DC	1
IF5*024Z05	LED	Single Colour with Buzzer	24V AC/DC	1
IF5P024XM05	LED	PLC Harmonized	24V DC	1
IF5P024ZM05	LED	PLC Harmonized + with Buzzer	24V DC	1
IFAB01		Pipe Adaptation Part		1
IKAM06		20mm Aluminium with Base (usable with IFAB01)		1

Note: In case of your base demand, please choice metal bases from page 48. Should be used with IFAB01

*Single Colour

R G Y B W R: Red, G: Green, Y: Yellow, B: Blue, W: White